

CENTA POWER TRANSMISSION
LEADING BY INNOVATION

CENTA is the leading producer of flexible couplings for industrial, marine and power generating applications. Worldwide.



PRODUCT INDEX

ENGLISH

WWW.CENTA.INFO/CONTACT

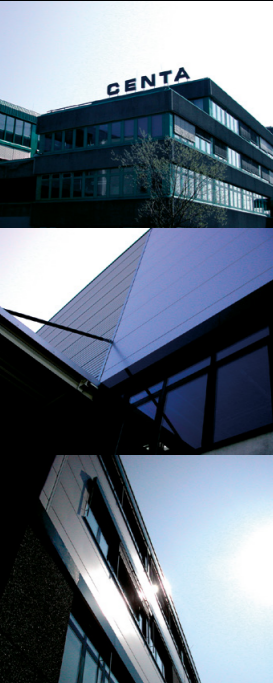

HEAD OFFICE

CENTA Antriebe
Kirschey GmbH

Bergische Strasse 7
42781 Haan/Germany

+49-2129-912-0 Phone
+49-2129-2790 Fax

info@centa.de
www.centa.info

PURE POWER

CENTA redefines POWER.
POWER, to us, is more than merely strength.

POWER, to us, is the passion to find the best solution. To continuously improve successful concepts. To set new standards in performance, flexibility and service.

Each product bearing the name CENTA puts POWER into practice in a unique way. Ensuring pure power. Removing troublesome influences. Enabling optimum results.

CENTA Power Transmission.
Leading by Innovation.

PRODUCTS FOR

RAIL



INDUSTRY



MARINE



ENERGY



PRODUCTS

SERIES		PAGE	SERIES		PAGE
CF-A	CENTAFLEX-A	7	CD-C	CENTADISC-C	11
CF-ACV	CENTAFLEX-ACV	7	CD-M	CENTADISC-M	11
CF-AGM	CENTAFLEX-AGM	7	CD-T	CENTADISC-T	12
CF-AM	CENTAFLEX-AM	7			
CF-B	CENTAFLEX-B	7			
CF-BL	CENTAFLEX-BL	8	CP	CENTA CLUTCH PACK	12
CF-CO	CENTAFLEX-CO	8	CARBON	CENTA CARBON	12
CF-D	CENTAFLEX-D	8	FH	CENTA FH	12
CF-DS	CENTAFLEX-DS	8	CL	CENTALINK	12
CF-E	CENTAFLEX-E	8	CS-V	CENTASTART-V	13
CF-H	CENTAFLEX-H	9			
CF-K	CENTAFLEX-K	9			
CF-KE	CENTAFLEX-KE	9	CX-B	CENTAX-SEC-B	13
CF-KF	CENTAFLEX-KF	9	CX-KS	CENTAX-KS	13
CF-M	CENTAFLEX-M	9	CX-KK	CENTAX-KK	13
CF-R	CENTAFLEX-R	10	CX-NL	CENTAX-SEC-NL	13
CF-RV	CENTAFLEX-RV	10	CX-G	CENTAX-SEC-G	14
CF-T	CENTAFLEX-T	10	CX-L	CENTAX-SEC-L	14
CF-X	CENTAFLEX-X	10	CX-TEST	CENTAX-TEST	14
			CX-TT	CENTAX-TT	14
			CX-V	CENTAX-V	15
CM-B	CENTAMAX-B	10			
CM-G	CENTAMAX-G	11			
CM-HTC	CENTAMAX-HTC	11			
CM-S	CENTAMAX-S	11			

CF-A

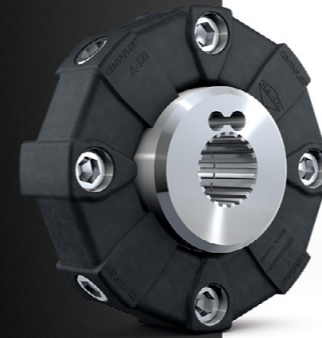

CENTAFLEX-A

www.centa.info/cf-a



Highly flexible coupling for a wide range of applications. For a maximum of design variants. Based on a highly elastic rubber element subject only to compressive stress. Extremely high-performing design with high torsional elasticity. Dampens torsional vibrations and shocks and compensates considerable axial, radial and angular misalignments. Electrically insulating and thermally resistant in silicon design. For rupture-proof and backlash-free transmission of high torques. Available as axially blind fitting design with radial mountability. Rubber element available as split element for quick replacement. Easy handling and mountable with minimum effort. In various lengths adaptable to the installation requirements if applied as homokinetic shaft. Also available as carbon-fibre or glass-fibre designs.

torque range
0.01 to 12.5 kNm

elastic material
NR / Si

temperature range
NR -45° to +80°C
Si -45° to +120°C

CF-ACV

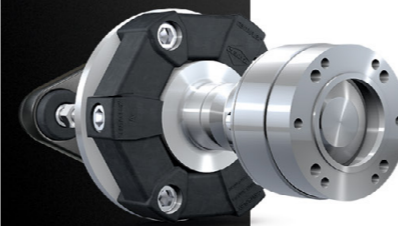

CENTAFLEX-ACV

www.centa.info/cf-acv



Highly flexible homokinetic drive shaft for the connection of gear and propeller shaft. For applications with considerable angular deflections. Torque transmission via a double-cardanic drive shaft with a CV joint on one side and a highly flexible rubber element on the other. Propeller thrust transmitted to the boat hull by a self-aligning thrust bearing. Specially designed to reduce noise and vibrations. Dampens torsional vibrations and shocks, interrupts structure-borne noise and tolerates (homokinetic) angular deflections of up to 8 resp. 3 degrees. Additionally offers a high degree of electrical insulation. Mounted with minimum effort by means of a clamping hub. Delivered with fail-safe device and to a large extent ready to install.

torque range
0.16 to 11 kNm

elastic material
NR

temperature range
-45° to +80°C

CF-AGM

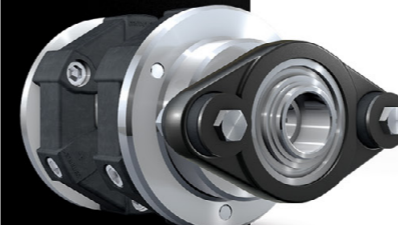

CENTAFLEX-AGM

www.centa.info/cf-agm



Highly flexible homokinetic drive shaft for the connection of gear and propeller shaft. For applications with moderate angular deflections. Backlash-free torque transmission via a double-cardanic drive shaft with two highly flexible rubber elements. Propeller thrust transmitted to the boat hull by a self-aligning thrust bearing. Specially designed to reduce noise and vibrations. Dampens torsional vibrations and shocks, interrupts structure-borne noise and tolerates (homokinetic) angular deflections of up to 3 degrees. Additionally offers a high degree of electrical insulation. Mounted with minimum effort by means of a clamping hub. Delivered with fail-safe device and to a large extent ready to install.

torque range
0.16 to 11 kNm

elastic material
NR

temperature range
-45° to +80°C

CF-AM



CENTAFLEX-AM

www.centa.info/cf-am



Highly flexible coupling for connecting gear and propeller shaft to isolate noise and vibration from the boat hull. Backlash-free transmission of torque and propeller thrust via a highly flexible rubber element with thrust bearing. Specially designed to reduce noise and vibrations. Dampens torsional vibrations and shocks, interrupts structure-borne noise and compensates moderate axial, radial and angular misalignments. Additionally offers a high degree of electrical insulation. Available in a wide range of standard sizes covering engine power up to several hundred kW. Mounted with minimum effort by means of a clamping hub. Delivered with fail-safe device and ready to install.

torque range
commercial 0.12 to 8 kNm
pleasure 0.175 to 10 kNm

elastic material
NR

temperature range
-45° to +80°C

CF-B



CENTAFLEX-B

www.centa.info/cf-b



Flexible shaft coupling in economical design. For maximum application flexibility. Extremely robust and fail-safe jaw-type design with elastomer element subjected only to compressive stress. Characterised by intermediate torsional stiffness with progressive characteristic. Dampens torsional vibrations and shocks and compensates axial, radial and angular misalignments. Many design variants and economical design. Oil-resistant and also available in thermally resistant design. As drive shaft available in any length required by the installation requirements. Delivered preassembled. Axial or radial mounting with minimum effort. CENTALOC clamping or taper lock bushes optionally available to prevent wear and frictional corrosion on not backlash-free hub to shaft connections.

torque range
0.032 to 1.4 kNm

elastic material
PU / TPE

temperature range
PU -40° to +80°C
TPE -50° to +150°C

CF-BL

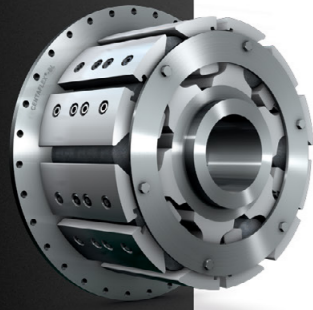

CENTAFLEX-BL

www.centa.info/cf-bl



A low maintenance robust claw type roller coupling for harsh impact loaded applications in electrical and heavy industrial applications. Steady and reliable transmission of the torque at a relatively small outer diameter. Easy and fast maintenance due to high modularity and standardization of the components as well as absolute system stability are features of this uniquely compact coupling for both rotation directions. And, the design is also impressive considering its dimensions and cost. The features of CENTAFLEX-BL ensure damping of impacts and overload as well as torsional vibrations and compensate for misalignments due to operation. Currently, the series covers torques ranging from 70 to 176 kNm.

torque range
70 to 176 kNm

elastic material
NR

temperature range
NR -45° to +80°C

CF-CO



CENTAFLEX-CO

www.centa.info/cf-co



Highly flexible coupling with almost linear characteristic. For drives subject to torsional vibration. Extremely robust and fail-safe construction with rubber rollers subjected only to compressive stress. Characterised by almost constant torsional stiffness throughout the entire torque range. Dampens torsional vibrations and shocks and compensates moderate axial, radial and angular misalignments. With extremely compact dimensions, effectively ventilated and with high allowable energy loss. Suitable for high ambient temperatures. The HD design includes oil-resistance. Blind assembly and free adjustability. Minimum maintenance effort. With flywheel connections acc. to SAE. Also available for non-standard flywheels.

torque range
0.08 to 0.5 kNm

elastic material
NR / Si

temperature range
NR -45° to +80°C
Si -45° to +120°C

CF-D



CENTAFLEX-D

www.centa.info/cf-d



Flexible flange coupling with progressive characteristic. For use in heavy duty applications. Extremely robust and fail-safe jaw-type construction with elastomeric buffers subjected only to compressive stress. Features medium torsional stiffness with progressive characteristic. Developed for a resonance-free operation of diesel-driven powertrains, particularly generators. Dampens torsional vibrations and shocks and compensates axial, radial and angular misalignments. Reliable and rupture-proof, in an especially short and economical design. Blind assembly for minimum mounting effort. With flywheel connections acc. to SAE. Also available for non-standard flywheels.

torque range
0.28 to 40 kNm

elastic material
NBR

temperature range
-25° to +80°C

CF-DS

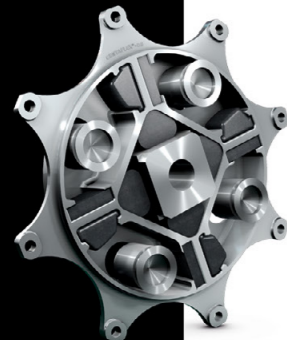

CENTAFLEX-DS

www.centa.info/cf-ds



Dual stage coupling with progressive characteristic. For smooth operation and reliable load transmission. Combines good damping characteristics of a torsionally flexible roller coupling under partial load with the robustness of a claw-type coupling under full load. Extremely short and economic design for smooth operation at low idling speeds resp. for applications with high degree of idling. Effectively ventilated and with high allowable power loss. Blind assembly for minimum mounting effort. Delivered with fail-safe device and flywheel connections acc. to SAE. Also available for non-standard flywheels.

torque range
0.15 to 1.75 kNm

elastic material
NR / NBR

temperature range
-25° to +80°C

CF-E



CENTAFLEX-E

www.centa.info/cf-e



Flexible shaft coupling for a wide range of applications. For safe transmission of high torques. Extremely robust and fail-safe jaw-type construction with elastomeric elements subjected only to compressive stress. Features medium torsional stiffness with progressive characteristic. For resonance-free operation and reliable transmission of high torques at low reaction forces. Dampens torsional vibrations and shocks and compensates axial, radial and angular misalignments. Heavy duty performance and compact dimensioning. Oil and temperature-resistant, rupture-proof and available in numerous standard and special designs. Available as homokinetic drive shaft in any length required by the installation. Axial blind assembly for minimum mounting effort.

torque range
0.075 to 40 kNm

elastic material
NBR

temperature range
-25° to +80°C

CF-H



CENTAFLEX-H

www.centa.info/cf-h



Torsionally stiff coupling with heavy duty performance. For resonance-free operation of diesel-hydraulic drives. Based on a flexible element of heavy duty elastomer with built-in aluminium or steel bushes. Especially powerful and compactly dimensioned design with high torsional stiffness. Dampens torsional vibrations and shocks and compensates high axial as well as moderate radial and angular misalignments. At the same time very durable and economical. Oil-resistant and suitable for extremely high temperatures. Blind assembly for minimum mounting effort. Available with CENTALOC clamping hub with flywheel connections acc. to SAE. Also available for non-standard flywheels.

torque range
0.1 to 4 kNm

elastic material
TPE

temperature range
-50° to +150°C

CF-K



CENTAFLEX-K

www.centa.info/cf-k



Compactly dimensioned coupling with high torsional stiffness. For resonance-free operation. Material combination of steel and highly shock-resistant glass-fibre reinforced plastic. Highly robust and short design with high torsional stiffness for fail-safe transmission of small to medium operation ranges. Enables optimum design adaptation to existing space requirements. Extremely durable and economical. Oil-resistant and suitable for high ambient temperatures. Blind assembly for minimum mounting effort. Delivered with preassembled hubstar and flywheel connections acc. to SAE. Also available with CENTALOC clamping hub and for non-standard flywheels.

torque range
0.4 to 5.2 kNm

elastic material
GFK

temperature range
-40° to +150°C

CF-KE



CENTAFLEX-KE

www.centa.info/cf-ke



Compactly dimensioned one piece design coupling with high torsional stiffness. For applications with radial misalignment. Flexible element made of high-quality glass-fibre reinforced plastic with elastic rubber-coated bushes on the outer diameter. Highly robust and short design with high torsional stiffness protecting shafts and bearings from mechanical loads. Tolerates moderate misalignments in radial direction. At the same time very durable and economical. Additionally oil-resistant and suitable for high ambient temperatures. Blind assembly for minimum mounting effort. Delivered ready to assemble and with flywheel connections acc. to SAE. Also available for non-standard flywheels.

torque range
0.2 to 0.6 kNm

elastic material
GFK

temperature range
-40° to +150°C

CF-KF

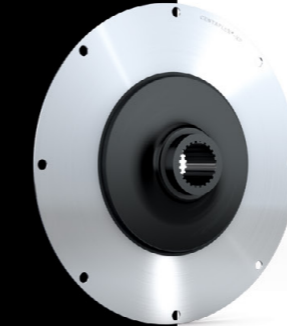

CENTAFLEX-KF

www.centa.info/cf-kf



A very cost efficient torsionally stiff and light weight coupling for the application in diesel hydraulic drives. A good choice where compensation of radial misalignments of up to 0.7 mm and temperature resistance up to max. 120°C – specially in sealed machines – are an issue. High torsional stiffness for subcritical operation. Axially short build, a special advantage for flywheel connections. Easy adaption for many flywheel and hub connections ensure flexibility of your drive. CENTAFLEX-KF consists of a lasered adapter plate for the flywheel connection, a secondary flange made of moulded reinforced plastic and a thin vulcanised layer of temperature resistant elastomer.

torque range
up to 800 Nm

elastic material
NR

temperature range
-40° to +120°C

CF-M

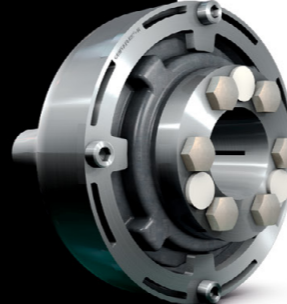

CENTAFLEX-M

www.centa.info/cf-m



Highly flexible coupling for the connection of gear and propeller shaft. For applications with limited mounting space. Backlash-free transmission of torque and propeller thrust via highly flexible rubber element. Specially designed to reduce noise and vibrations under confined space requirements. Dampens torsional vibrations and shocks, interrupts structure-borne noise and compensates axial, radial and angular misalignments. Additionally offers a high degree of electrical insulation. Mounted with minimum effort by means of a clamping hub. Delivered with fail-safe device and ready to install. Further handling, maintenance and cost benefits by omitting additional components, such as spacers.

torque range
commercial 0.175 to 0.35 kNm
pleasure 0.25 to 0.5 kNm

elastic material
NR

temperature range
-45° to +80°C

CF-R



CENTAFLEX-R

www.centa.info/cf-r



Highly flexible coupling with progressive characteristic. For heavy duty applications. Extremely robust and fail-safe design with rubber rollers subjected only to compressive stress. Characterised by a slight stiffness at lower speeds and a moderately increased stiffness at rising torques. For smooth operation and reliable transmission over the entire operation range. Also effectively ventilated and with high allowable energy loss. Suitable for high ambient temperatures. HD design includes oil-resistance and even higher temperature resistance. Delivered with fail-safe device and for a variety of shaft connections. With flywheel connections acc. to SAE. Also available for non-standard flywheels.

torque range
0.25 to 15 kNm

elastic material
CENTALAN / HD

temperature range
CENTALAN -45° to +100°C
HD -45° to +130°C

CF-RV



CENTAFLEX-RV

www.centa.info/cf-rv



Highly flexible intermediate coupling with progressive characteristic. For drive concepts with many drive shaft variants. Combination of highly flexible roller coupling and built-in bearing support. Characterised by slight stiffness at lower speeds and moderately increased stiffness at rising torques. Dampens torsional vibrations and noise. Ensures smooth operation and long lifespan of the coupled units. HD design includes oil-resistance and even higher temperature resistance. Minimum mounting and maintenance effort. With flywheel connections acc. to SAE. Also available for non-standard flywheels. CENTA FH flange bearing is recommended for larger deflection angles of connected cardan shafts.

torque range
1.6 to 10 kNm

elastic material
CENTALAN / HD

temperature range
CENTALAN -45° to +100°C
HD -45° to +130°C

CF-T



CENTAFLEX-T

www.centa.info/cf-t



Torsionally stiff wedge type coupling with optimised geometry. For high torques in confined spaces. Based on a bridge bearing principle allowing a high power density and good misalignment properties. Torsionally stiff design, however, highly flexible in axial and angular directions ensuring reliable compensation of misalignments. Proves superior when compared to standard wedge type solutions by an extremely compact design and high performance density achieved by optimising its geometry and omitting the hubstar. Also available as homokinetic drive shaft. Further handling, maintenance and cost benefits through a reduced number of wedged elements. Easy and safe integration into the drive train.

torque range
1.2 to 24 kNm

elastic material
NR

temperature range
-45° to +80°C

CF-X



CENTAFLEX-X

www.centa.info/cf-x



Torsionally stiff coupling with high power density. For applications under extreme conditions. Based on a flexible element of heavy duty plastics with pressed-in steel bushes. Especially high-performance and rupture-proof design with high torsional stiffness. Bending elasticity properties allow for compensation of axial and angular misalignments. As a drive shaft, offers additional radial flexibility. Extremely light-weight and compact design. Oil-resistant, effectively ventilated and suitable for extremely high ambient temperatures. Design type X-S features axial blind assembly for minimum mounting effort. With flywheel connections acc. to SAE.

torque range
0.01 to 1.5 kNm

elastic material
PA

temperature range
up to app. +150°C

CM-B



CENTAMAX-B

www.centa.info/cm-b



Robust coupling with high torsional flexibility, especially for independently mounted gensets. For backlash-free transmission of medium torques. Backlash-free torque transmission via a steel flange onto a precompressed rubber element. Extremely fail-safe and low-wear design for transmission of medium torques. Characterised by high torsional flexibility with linear characteristic. Dampens torsional vibrations and shocks and compensates axial and angular misalignments. Economic design effectively ventilated and with high allowable energy loss. Blind assembly for minimum mounting effort. Easy radial replacement and maintainable design. With flywheel connections acc. to SAE. Also available for non-standard flywheels and as shaft-to-shaft connection.

torque range
0.7 to 15 kNm

elastic material
NR / Si

temperature range
NR -45° to +80°C
Si -45° to +120°C

CM-G



CENTAMAX-G

www.centa.info/cm-g



Robust coupling with high torsional flexibility. For quick and easy mounting in drives subject to torsional vibration particularly on gensets. Transmission of torque via toothed outer ring onto a rubber element. Additionally equipped with a taper locking bush for quick and easy installation. Highly dependable and fail-safe design. Characterised by high torsional flexibility with linear characteristic. Dampens torsional vibrations and shocks and compensates axial, radial and angular misalignments. Effectively ventilated and with high allowable energy loss. Blind assembly for minimum mounting effort. With flywheel connections acc. to SAE. Also available for engine and generator connections acc. to DIN 6281.

torque range
1.2 to 7 kNm

elastic material
NR

temperature range
-45° to +80°C

CM-HTC



CENTAMAX-HTC

www.centa.info/cm-htc



Torsionally highly flexible coupling with high energy loss. For drives subject to torsional vibration. Torque transmission via a toothed outer ring onto a rubber element divided into two slim halves. With optimised higher allowable energy loss due to increased surface, reduced heat dissipation and effective ventilation. Dampens torsional vibrations and shocks and compensates axial, radial and angular misalignments. Proves superior when compared to standard double couplings by extremely compact dimensions and economic design. Blind assembly for minimum mounting effort. With flywheel connections acc. to SAE. Also available for non-standard flywheels.

torque range
5.4 to 45 kNm

elastic material
NR

temperature range
-45° to +80°C

CM-S



CENTAMAX-S

www.centa.info/cm-s



Robust coupling with high torsional flexibility. For resonance-free operation of drives susceptible to torsional vibration. Torque transmission via a toothed outer ring onto a rubber element. Highly reliable and rupture-proof design for transmission of high torques in a compact design. Characterised by high torsional flexibility with linear characteristic. Dampens torsional vibrations and shocks and compensates axial, radial and angular misalignments. Effectively ventilated and with high allowable energy loss. Additionally oil-resistant in silicone design. Blind assembly for minimum mounting effort. With flywheel connections acc. to SAE. Also available for non-standard flywheels.

torque range
0.1 to 24 kNm

elastic material
NR / Si

temperature range
NR -45° to +80°C
Si -45° to +120°C

CD-C

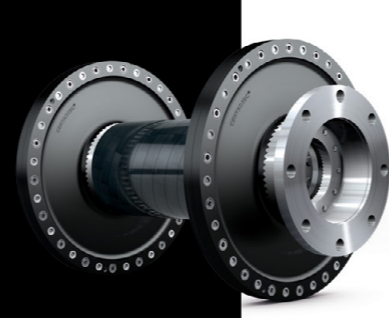

CENTADISC-C

www.centa.info/cd-c



A torsionally stiff light weight membrane coupling for the application in vessels, ferries and in wind energy applications where weight and alignment are of importance. Two membranes arranged in series and combined with a fibre reinforced tube function as kinematic joint with optimum operating characteristics. Stiff and lightweight tubes allow for high speeds thus longer driveshafts are possible in with substantially reduced bearings. The combination with further CENTA products, cardanshafts, homokinetic joints or couplings on the other shaft end guarantee for optimal adaption. Positive fit of all components by standardized serration between coupling element and tube or power unit. Easy handling due to modular design and standardization.

torque range
1 to 50 kNm

elastic material
PA / GFK

temperature range
-40° to +150°C

CD-M

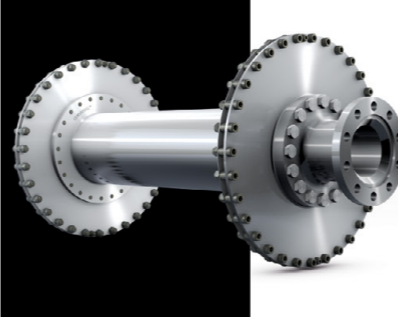

CENTADISC-M

www.centa.info/cd-m



High-performing drive shaft with tandem membrane. For light-weight design. Double-cardanic system with two tandem membranes in series and an intermediate tube made of steel or carbon-fibre reinforced plastic. Torsionally stiff design, yet capable of compensating considerable axial misalignments. Ideal for long spans due to low weight and high strength as so eliminating the need for additional intermediate bearings. Extremely durable, also oil-resistant and suitable for high ambient temperatures. Available in any length with up to 10 metres per section. Radially mountable and with minimum maintenance effort. Further handling, maintenance and cost benefits by the omission of additional components, such as bearings and foundations.

torque range
12.5 to 650 kNm

CD-T

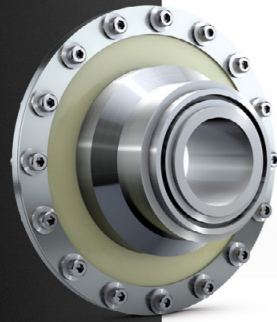

CENTADISC-T

www.centa.info/cd-t



The membrane coupling with option for integrated overload function for applications in rail drives between e-motor and gear. Optimum application in drives on one bearing, where the rotor of the electric engine is born via the coupling. A new feature to the base design is added by electrical insulation within the membrane. Layout and design are identical to the steel variant in handling and technical data. Large insulation spans eliminate leakage or high frequency currents. High capacity resistance and optimum protection of the driven side are the result. This new design is an individual solution for customer specific unit combinations and is combined with overload slip units within the clamping hubs.

torque range on request

elastic material GRP

CP



CENTA CLUTCH PACK

www.centa.info/cp



Versatile clutch coupling with flange bearing. For short engaging operations and effective protection against mechanical loads. Combination of a torsional coupling with an electro-magnetic clutch coupling, installed inside a flanged bearing housing. Highly robust design with reliable bearing. Allows starting and stopping the driven unit under load and protects connected shafts and bearings against harmful reaction forces. Effectively ventilated with high allowable energy loss. Short total length, extremely economic design when compared to standard hydraulically operated couplings. Can be operated with on-board voltage.

Delivered preassembled. With flywheel connections acc. to SAE.

torque range 0.7 to 4.2 kNm

elastic material and temperature range dependent upon the coupling installed

CARBON

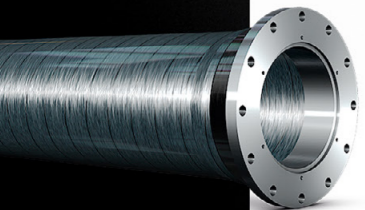

CENTA CARBON

www.centa.info/carbon



Light-weight drive shaft made of carbon-fibre reinforced plastic. For energy-efficient power transmission while simultaneously permitting increased velocities of the driven machines. Developed in cooperation with the Technical University of Darmstadt and leading classification societies. Strength and stability comparable to steel, but significant savings in weight. Combinable with a variety of flexible couplings and connecting elements for optimum adaptation of the torsional situation. Extremely durable and noise damping. With low thermal expansion, fatigue-free and corrosion-proof. Available in any length with up to 10 metres per section. Further handling, maintenance and cost benefits by the omission of additional components, such as bearings and foundations.

torque range 0.1 to 650 kNm

elastic material CFK

temperature range -40° to +90°C

FH



CENTA FH

www.centa.info/fh



Flange bearing to protect engine crankshafts from high bending moments. For compensation of high forces resulting from large deflection angles of connected components. Robust flanged bearing housing made of tempered aluminium. Extremely easy maintainable design on durable bearing. Takes up reaction forces and transmits them to the flywheel housing for the protection of the crankshaft and its bearing. Also available with speed-controlled centrifugal clutch for soft engagement of connected components. Extremely light-weight and compact design. Effectively ventilated. Minimum mounting and maintenance effort. Preassembled as unit for flywheel connections acc. SAE.

torque range 0.77 to 24 kNm

elastic material and temperature range dependent upon the coupling installed

CL

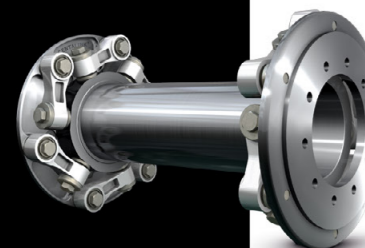

CENTALINK

www.centa.info/cl



Torsionally stiff drive shaft with outstanding kinematics. For reliable misalignment compensation and smooth operation. Equipped with links designed for push and pull, and bolted together with flexible rubber bushes. Extremely high-performing and torsionally stiff design with linear characteristic. Unique design with ability to compensate axial, radial and angular misalignments. In addition, offers the utmost degree of electrical insulation and reliable interruption of structure-borne noise. Protects the system against electrical corrosion and ensures significant reduction in noise transmission. Reduces installation time to a minimum and keeps lifecycle costs low. Available in optional intermediate and special sizes within the wide standard series. Also available as carbon-fibre or glass-fibre design.

torque range 3.3 to 150 kNm

temperature range -45° to +80°C

CS-V

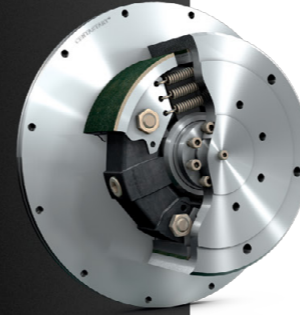

CENTASTART-V

www.centa.info/cs-v



Speed-controlled centrifugal clutch with high flexibility. For zero-loss power transmission. Combination of a highly flexible rubber element, subjected only to compressive stress, and several centrifugal weights with friction lining connected by tension springs. Thermally resistant design with precisely determinable engaging speed. Allows complete separation of frictional connection as well as soft engaging and slip-free power transmission when reaching engagement speed. Extremely compact dimensions, additionally protects against overload. Available in numerous standard and special designs. With flywheel connections acc. to SAE. Also available for non-standard flywheels.

torque range 0.08 to 2.5 kNm

elastic material NR

temperature range -45° to +80°C

CX-B



CENTAX-SEC-B

www.centa.info/cx-b



Robust coupling in economic design. For drives with high axial misalignments. Ring element featuring high torsional flexibility and radial capacity, combined with axial pins and bushes. Very reliable design, easy to install. With medium to high torsional flexibility. Available in various Shore hardness, ensuring optimum tuning of the torsional system. Dampens torsional vibrations and shocks and compensates considerable axial and radial misalignments. Effectively ventilated and with high allowable energy loss. Also available as segmented design. Mounted axially or radially with minimum effort. Extreme easy maintainable and durable.

torque range 5.5 to 260 kNm

elastic material NR

temperature range -45° to +80°C

CX-NL



CENTAX-SEC-NL

www.centa.info/cx-nl



Torsionally high flexible coupling with linear characteristic. For applications in soft mounted drive concepts. Ring element featuring high torsional and radial flexibility, combined with flexibility in axial and angular directions. Designed with amply dimensioned secondary inertia. With high torsional flexibility and extreme variable adaption to the individual torsional requirements by use of various degrees of Shore hardness. Dampens torsional vibrations and shocks and compensates considerable axial, radial and angular misalignments. Effectively ventilated and with high allowable energy loss. Minimum mounting effort. Fail-safe device optionally available. With flywheel connections acc. to SAE.

torque range 1.1 to 25 kNm

elastic material NR

temperature range -45° to +80°C

CX-KS



CENTAX-K

www.centa.info/cx-k



A coupling for diesel-driven compressor or pump drives should have one primary feature: to be as uncompromising regarding ease in mounting as our new CENTAX-K.

torque range 0.4 to 0.8 kNm

The torsionally soft coupling is based on a rubber element that features high torsional flexibility and radial movability vulcanised to a glass-fibre reinforced plastic flange with an integrated hub on the output side of the KS design and a separate hub star for the KK design. The coupling designs can be plugged in axially to ensure maximum ease in mounting. And, the design is also impressive considering its dimensions and cost.

elastic material NR / Si

temperature range NR -45° to +80°C Si -45° to +120°C

The torsional flexibility of the CENTAX-KS dampens torsional vibrations and impacts and compensates for any axial and radial misalignments due to operation. The rubber element for this coupling is available in various designs.

CX-KK



Currently, the series covers torques ranging from 400 to 800 Nm.

CENTA PRODUCT INDEX

CX-G



CENTAX-SEC-G

www.centa.info/cx-g



Highly elastic membrane coupling with high misalignment capability. For use in flexible-mounted drive concepts. Rubber element featuring high torsional and radial flexibility, combined with a membrane flexible in axial and angular directions. With high torsional flexibility and especially ideal system adaption by selection of one row or multi-row arrangement and different degrees of Shore hardness. Dampens torsional vibrations and shocks and compensates axial, radial and angular misalignments. Effectively ventilated and with high allowable energy loss. Available with ring element or with segmented rubber element. Fail-safe device optionally available. Flanges and hubs available in numerous variants.

torque range
2.25 to 650 kNm

elastic material
NR

temperature range
-45° to +80°C

CX-L

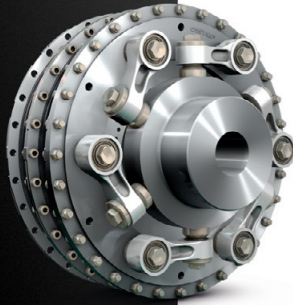

CENTAX-SEC-L

www.centa.info/cx-l



Highly elastic link coupling with excellent misalignment capability. For use in soft-mounted drives. Rubber element featuring high torsional and radial flexibility, combined with links flexible in axial and angular directions. With high torsional flexibility and especially ideal system adaption by selection of one row or multi-row arrangement and between different degrees of Shore hardness. Dampens torsional vibrations and shocks and compensates considerable axial, radial and angular misalignments. Additionally provides reliable acoustic decoupling. Effectively ventilated and with high allowable energy loss. Available with ring element or with segmented rubber element. Fail-safe device optionally available. Flanges and hubs available in numerous variants.

torque range
2.25 to 330 kNm

elastic material
NR

temperature range
-45° to +80°C

CX-TEST

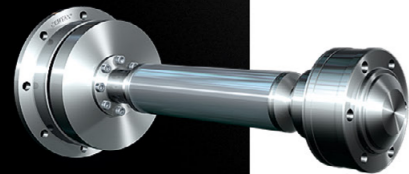

CENTAX-TEST

www.centa.info/cx-test



Highly flexible test bed coupling for high speeds. For optimum test conditions. Based on a highly flexible rubber element, combinable with homokinetic joints, cardan joints, slip joints, etc., as demanded by test requirements. Extremely adaptable design with high torsional flexibility. Dampens torsional vibrations and shocks and compensates axial, radial and angular misalignments. Suitable for high speed ranges and long-term tests. Available in any length and mounting dimensions adaptable to the respective test situation. Easy mounting as slip joints and elements can be shifted in axial direction. Customised solutions for automatic docking onto combustion engines are optionally available.

torque range
0.28 to 0.45 kNm

elastic material
NR

temperature range
-45° to +80°C

CX-TT



CENTAX-TT

www.centa.info/cx-tt



Compact coupling with high performance density. For heavy duty applications with high speeds. Design with segmented rubber elements, each consisting of two concentrically arranged precompressed rubber segments, which jointly transmit the torque. Extremely short and high-performing design. Characterised by medium torsional stiffness, especially variable adaption to the torsional system by adjusting the number and the arrangement of the segments. Dampens torsional vibrations and shocks and compensates axial and radial misalignments. Effectively ventilated and with high admissible energy loss. Mounted with minimum effort, replaceable without movement of the coupled units.

torque range
17.6 to 500 kNm

elastic material
NR

temperature range
-45° to +80°C

CX-V



CENTAX-V

www.centa.info/cx-v



Torsionally highly flexible intermediate coupling with linear characteristic. For drive concepts with cardan shafts. Safe transmission of torque via a highly flexible precompressed rubber element with precisely centred plain bearings. Characterised by high torsional flexibility with linear characteristic. Dampens torsional vibrations and noise, ensures smooth operation and long service life of the connected units. Also effectively ventilated and with high allowable energy loss. Available with flywheel connections acc. to SAE and various cardan connections. Also available for non-standard flywheels. Flange bearing CENTA FH recommended for larger deflection angles.

torque range
0.23 to 50 kNm

elastic material
NR

temperature range
-45° to +80°C

CENTA POWER TRANSMISSION LEADING BY INNOVATION

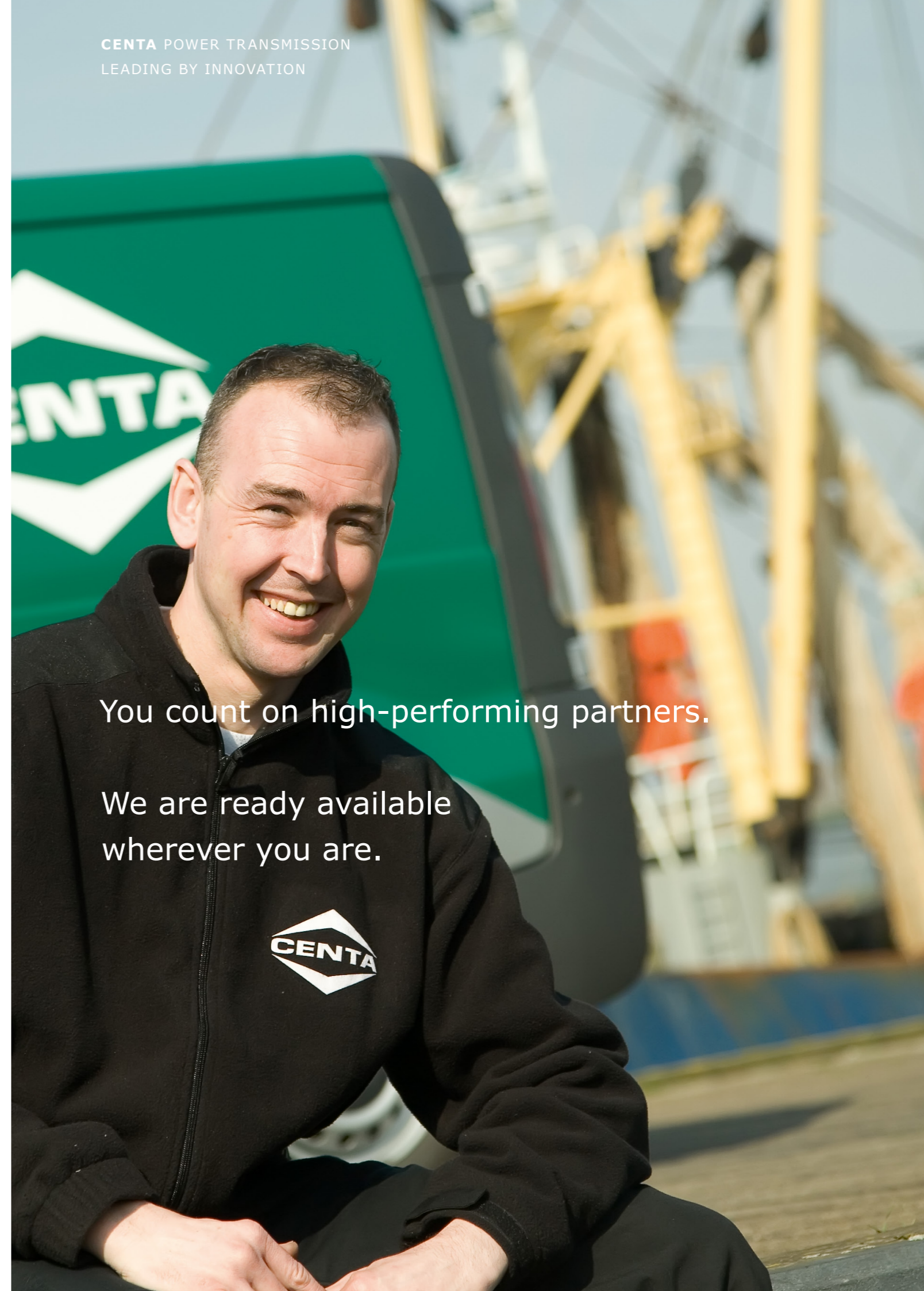

You count on high-performing partners.

We are ready available
wherever you are.