

How To Use This Manual

This manual provides detailed instructions on installation, maintenance and parts identification for Falk Lifalign® gear couplings, Type GL. Use the table of contents below to locate required information.

Table of Contents

Introduction	Page 1
Lube Fittings.....	Page 1
Lubrication.....	Pages 1-2
Balanced Couplings	Page 3
Installation & Alignment Instructions	Pages 3-4
Annual Maintenance.....	Page 4
Installation & Alignment Data	Page 5
Parts Identification & Parts Interchangeability	Page 6

CAREFULLY FOLLOW THE INSTRUCTIONS IN THIS MANUAL FOR OPTIMUM PERFORMANCE AND TROUBLE FREE SERVICE.

Introduction

This manual applies to standard coupling Types GL20 with exposed bolts. For couplings furnished with special features, refer to assembly drawing furnished with coupling for proper assembly arrangement and any additional installation or maintenance requirements. Type GL20 couplings are recommended for applications that require axial hub movement and are designed for horizontal operations. Refer to Factory for vertical applications.

CAUTION: Consult applicable local and national safety codes for proper guarding of rotating members. Observe all safety rules when installing or servicing couplings.

WARNING: Lockout starting switch of prime mover and remove all external loads from drive before installing or servicing couplings.

Lube Fittings

Sleeves have 1/8 NPT lube holes for sizes 1010GL thru 1035GL, and 1/4 NPT for sizes 1040GL thru 1070GL. Use a standard grease gun and lube fittings.

Lubrication

Adequate lubrication is essential for satisfactory operation. Because of its superior lubricating characteristics and low centrifuge properties, Falk Long Term Grease (LTG) is highly recommended.

Gear couplings initially lubricated with Falk Long Term grease (LTG) will not require re-lubrication for up to three years.

The use of general purpose grease requires re-lubrication of the coupling at least every six months. If coupling leaks grease, is exposed to extreme temperatures, excessive moisture, experiences frequent reversals or axial movements; more frequent lubrication may be required.

Type GL20

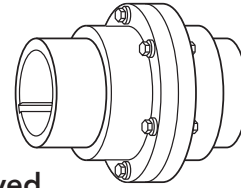

USDA Approved

LTG has the United States Department of Agriculture Food Safety & Inspection Service approval for applications where there is no possibility of contact with edible products. (H-2 ratings).

Long Term Grease (LTG)

The high centrifugal forces encountered in couplings separate the base oil and thickener of general purpose greases. Heavy thickener, which has no lubrication qualities, accumulates in the tooth mesh area of gear couplings resulting in premature mesh failure unless periodic lubrication cycles are maintained.

Falk Long Term Grease (LTG) was developed specifically for couplings. It resists separation of the oil and thickener. The consistency of Falk LTG changes with operating conditions. As manufactured it is an NLGI #1/2 grade. Working of the lubricant under actual service conditions causes it to become semifluid while the grease near the seals will set to a heavier grade, helping to prevent leakage. LTG is highly resistant to separation, easily out performing all other lubricants tested. The resistance to separation allows the lubricant to be used for relatively long periods of time.

Although LTG grease is compatible with most other coupling greases, the mixing of greases may dilute the benefits of LTG.

CAUTION: Do not use LTG in bearings. Do not use LTG for low speed applications. Refer to Table 1 for coupling speed range of LTG grease.

Packaging

14 oz. (.4 Kg) CARTRIDGES — Individual or case lots of 10 or 60.

35 lb. (16 Kg) PAILS, 120 lb. (54 Kg) KEG & 400 lb. DRUMS.

Specifications — Falk LTG (Long Term Grease)

TEMPERATURE RANGE — -20°F (-29°C) to 250°F (121°C). Minimum pump = 20°F (-7°C).

MINIMUM BASE OIL VISCOSITY — 3300SSU (715cSt) @ 100°F (38°C).

THICKENER — Lithium soap/polymer.

CENTRIFUGE SEPARATION CHARACTERISTICS — ASTM #D4425-84 (Centrifuge Test) — K36 = 2/24 max, very high resistance to centrifuging.

NLGI GRADE (ASTM D-217) — 1/2

CONSISTENCY (ASTM D-217) — 60 stroke worked penetration value in the range of 315 to 360 measured @ 77°F (25°C).

DROPPING POINT — 350°F (177°C) minimum.

MINIMUM TIMKEN EP O.K. LOAD — 40 lb (18 kg).

ADDITIVES — Rust and oxidation inhibitors that do not corrode steel or swell or deteriorate synthetic seals.

General Purpose Grease

Bi-annual Lubrication — The following specifications and lubricants for general purpose grease apply to gear couplings that are lubricated bi-annually and operate within ambient temperatures of -30°F (-34°C) to 200°F (93°C). For temperatures beyond this range, consult the Factory. For normal service, use a NLGI #1 extreme pressure (EP) grease EXCEPT when the coupling speed is less than the minimum specified in Table 1, Page 5. At these lower speeds, use a NLGI #0 extreme pressure (EP) grease. When one or more gear couplings in an application require NLGI #0 grease, the same grease may be used in all of the couplings. DO NOT use cup grease.

If coupling leaks grease, is exposed to extreme temperatures, excessive moisture or experiences frequent reversals or axial movements; more frequent lubrication may be required.

Specifications — General Purpose Coupling Lubricants

COUPLING SPEED RANGE — See Table 1.

TEMPERATURE RANGE — -30°F to $+200^{\circ}\text{F}$ (-34°C TO 93°C).

WORKED PENETRATION AT 77°F (25°C) —

NLGI #1 310-340

NLGI #0 355-385

DROPPING POINT — 300°F (149°C) or higher.

TEXTURE — Smooth or fibrous.

MINIMUM TIMKEN O.K. LOAD — 30 lb.

SEPARATION AND RESISTANCE — Low oil separation rate and high resistance to separation from centrifuging.

LIQUID CONSTITUENT — Possess good lubricating properties . . . equivalent to a high quality, well refined petroleum oil with EP additives.

INACTIVE — Must not corrode steel or cause swelling or deterioration of synthetic seals.

Oil Lubrication

EP oils may be a more effective lubricant than grease when the required coupling speed is one half of the minimum speed range of NLGI #1 grease listed in Table 1 (Minimum rpm $\div 2$). Oil lubricated couplings must be sealed to prevent leakage, i.e. keyways, etc. Couplings must be drained and refilled with new oil every six months for operating temperatures up to 160°F (71°C) and every three months for couplings operating at temperatures of 160°F (71°C) up to 200°F (93°C). For temperatures beyond this range, consult the Factory. The minimum operating temperature must not be lower than the pour point of the oil. The specified amount of grease listed in Table 1, Page 5, in pounds and kilograms and also applies to the volume of oil in pints.

Specifications

Type: Mild EP gear oil that meets AGMA Specifications 250.04.

Grade: AGMA #8EP (ISO VG 680).

Viscosity: 612-748 cSt @ 104°F (40°C).

Pour Point: 20°F (-7°C) Maximum.

Must not corrode steel or swell or deteriorate synthetic seals.

Type GL Horizontal Coupling Installation

Only standard mechanics tools, torque wrenches, dial indicator spacer bar, straight edge, and feeler gauges are required to install gear couplings. Clean all parts using a non-flammable solvent. Check hubs, shafts and keyways for burrs. DO NOT heat clearance fit hubs. Use a lubricant that meets the specifications on Page 1 or 2. Pack sleeve teeth with grease and lightly coat seals with grease BEFORE assembly. The required amount of grease is listed in Table 1, Page 5. Make certain flange fasteners are tightened to the required torque listed in Table 1, Page 5.

Interference Fit Hubs — Unless otherwise specified, gear couplings are furnished for an interference fit without set screws. Heat hubs to 275°F (135°C) using an oven, torch, induction heater or an oil bath.

CAUTION: To prevent seal damage DO NOT heat hubs beyond a maximum temperature of 400°F (205°C).

When an oxy-acetylene or blow torch is used, use an excess acetylene mixture. Mark hubs near the center of their length in several places on hub body with a temperature sensitive crayon, 275°F (135°C) melt temperature. Direct flame towards hub bore using constant motion to avoid overheating an area.

WARNING: If an oil bath is used, the oil must have a flash point of 350°F (177°C) or higher. Do not rest hubs on the bottom of the container. Do not use an open flame in a combustible atmosphere or near combustible materials.

Maximize Performance & Life

The performance and life of couplings depend largely upon how you install and maintain them. Before installing couplings, make certain that foundations of equipment to be connected meet manufacturers' requirements. Check for soft foot. The use of stainless steel shims is recommended. Measuring misalignment and positioning equipment within alignment tolerances is simplified with an alignment computer. These calculations can also be done graphically or mathematically, and allow the incorporation of "cold offsets", which will compensate for shaft position changes due to thermal growth.

Balanced Couplings

The fasteners provided are matched sets and must not be mixed or substituted. Assembly balanced couplings are match marked and must be assembled with mating match marks aligned. In some sizes, the flanges are not match marked. Coupling flanges must be assembled with O. D.'s aligned to within .002". Component parts of assembly balanced couplings must not be replaced without re-balancing the complete assembly.

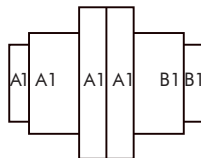

1 — Determine Coupling Assembly Number

Measure flex hub dimension ZG or ZGL, as shown in drawings on Page 6. Compare the results with the values listed in Table 1 and compare coupling parts provided to the part identification drawings on Page 6 to determine if coupling is a GL20-1, GL20-2, or GL20-4. **NOTE:** GL20-4 couplings are provided with short tooth sleeves, and gap discs.

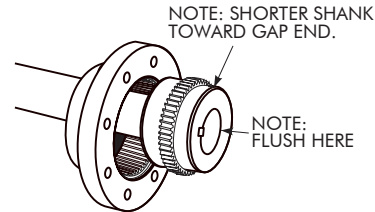

2 — Mount Flanged Sleeve, Seal & Hubs

Place the flanged sleeves WITH seal rings on shafts BEFORE mounting hubs.

IMPORTANT: Mount hubs as shown above with SHORT shank, DIM. ZG or ZGL in Table 1 on Page 5, toward gap. Mount hubs so that each face is flush with the end of its shaft. Allow hubs to cool before proceeding. Seal keyways to prevent leakage. Insert set screws (if required) and tighten.

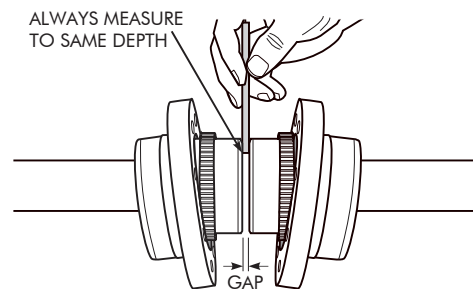

3 — Gap & Angular Alignment

Adjust gap to any value between minimum and maximum value specified in Table 1 on Page 5. Axial movement must never exceed the minimum and maximum gap values and EACH hub travel must never exceed its "T" value. ("T" equals max gap minus min gap divided by two.) Temporarily secure the shafts at their required positions. Insert a spacer bar equal in thickness to the required gap at 90° intervals to the same depth as shown. Measure clearance between bar and hub face with a feeler gauge. The difference in minimum and maximum measurements should not exceed the INSTALLATION ANGULAR limit specified in Table 1 on Page 5.

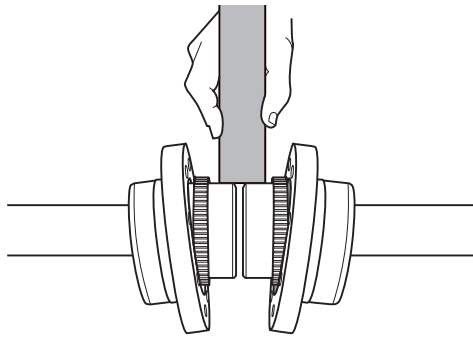

4 — Offset Alignment

Align so that a straight edge rests squarely on both hubs as shown above and also at 90° intervals. Check with feelers. The clearance should not exceed the INSTALLATION OFFSET limit specified in Table 1. Tighten foundation bolts and repeat Steps 3 and 4. Realign coupling if necessary. Use a dial indicator if hub extension is too short for accurate use of a straight edge.

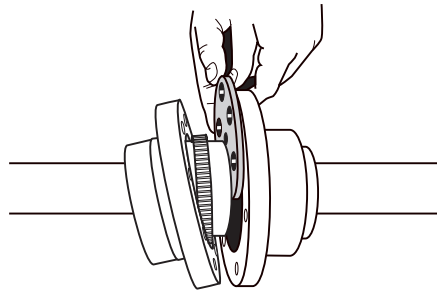

5 — Insert Center Plate and Assemble Coupling

Position one flanged sleeve on the hub and insert the centerplate into the sleeve counterbore as shown. (For GL20-4, also insert two Gap Discs, Part #19, as shown on Page 6.) Insert gasket and assemble second flanged sleeve with lube holes approximately 90° apart. Use only the fasteners furnished with the coupling.

IMPORTANT: Tighten fasteners to torque specified in Table 1 on Page 5.

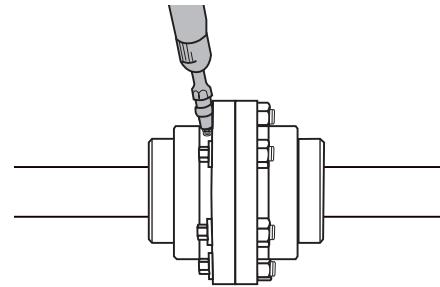

6 — Lubricate

Insert a lube fitting into one lube hole and remove opposite plug for venting. Fill to ONE-HALF of the amount of lubricant specified in Table 1. REPEAT the procedure for other half coupling and then INSERT ALL LUBE PLUGS.

IMPORTANT: Over lubrication may restrict the sliding action of the coupling.

Bi-Annual Maintenance

Re-lubricate coupling if using general purpose greases. If coupling leaks grease, is exposed to extreme temperatures, excessive moisture or frequent reversals; more frequent lubrication may be required.

Annual Maintenance

For extreme or unusual operating conditions, check coupling more frequently.

1. Check alignment per Step 7 below. If the maximum operating misalignment values are exceeded, realign the coupling to the recommended installation values. See Table 1, Page 5, for installation and maximum operating misalignment values.
2. Check tightening torques of all fasteners.
3. Inspect seal ring and gasket to determine if replacement is required.
4. Re-lubricate coupling if using general purpose grease.

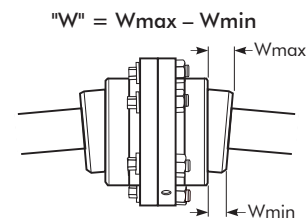

Check "W" at each flexible hub.

7 — Assembled Coupling Alignment Check

The alignment can be checked without disassembling the coupling as shown above. Determine "W" by measuring distances "W" max and "W" min between flex hub and sleeve using a depth mic or feeler gages. The difference between "W" max and "W" min must not exceed the "W" value given in Table 1. Check "W" at each coupling end.

TABLE 1 — Installation and Alignment Data ★ Dimensions – Inches (Metric – mm)

COUPLING SIZE			1010	1015	1020	1025	1030	1035	1040	1045	1050	1055	1060	1070
Dimensions	ZG		.586 (14.884)	.500 (12.700)	.700 (17.780)	.860 (21.844)	.960 (24.384)	1.060 (26.924)	1.080 (27.432)	1.240 (31.496)	1.370 (34.798)	1.290 (32.766)	1.670 (42.418)	1.960 (49.784)
	ZGL		.000 (0.000)	.000 (0.000)	.000 (0.000)	.000 (0.000)	.250 (6.350)	.250 (6.350)	.250 (6.350)	.250 (6.350)	.360 (9.144)	.500 (12.700)	.500 (12.700)	.530 (13.462)
Gap (Hub Separation)	Min	GL20 - 1 & 2	.31 (7.874)	.31 (7.874)	.31 (7.874)	.37 (9.398)	.37 (9.398)	.45 (11.430)	.57 (14.478)	.63 (16.002)	.71 (18.034)	.71 (18.034)	.83 (21.082)	1.04 (26.416)
		GL20 - 4	.24 (6.096)	.54 (13.716)	.26 (6.604)	.84 (21.336)	.86 (21.844)	1.29 (32.766)	1.83 (46.482)	1.85 (46.990)	2.38 (60.482)	3.61 (91.694)	3.06 (77.724)	3.79 (96.266)
	Max	GL20 - 1 & 4	.41 (10.414)	1.13 (28.702)	1.05 (26.670)	1.33 (33.782)	1.77 (44.958)	2.39 (60.706)	3.11 (78.994)	3.37 (85.598)	4.01 (101.854)	5.27 (133.858)	5.01 (127.254)	5.92 (150.368)
		GL20 - 2	1.59 (40.386)	2.13 (54.102)	2.45 (62.230)	3.05 (77.470)	3.19 (81.026)	4.01 (101.854)	4.77 (121.158)	5.35 (135.890)	6.03 (153.162)	6.85 (173.990)	7.35 (186.690)	8.78 (223.012)
Installation Limits	Offset Max		.002 (.0508)	.002 (.0508)	.002 (.0508)	.002 (.0508)	.004 (.102)	.004 (.102)	.005 (.127)	.005 (.127)	.006 (.152)	.007 (.178)	.008 (.203)	.009 (.229)
	Angular Max		.006 (.152)	.007 (.178)	.009 (.229)	.011 (.279)	.013 (.330)	.015 (.381)	.018 (.457)	.020 (.508)	.022 (.559)	.024 (.610)	.026 (.660)	.031 (.787)
"W" †	Installation Limit Check		.006 (.152)	.007 (.178)	.009 (.229)	.011 (.279)	.013 (.330)	.015 (.381)	.018 (.457)	.020 (.508)	.022 (.559)	.024 (.610)	.026 (.660)	.031 (.787)
	Operating Limit Check		.012 (.305)	.015 (.381)	.018 (.457)	.022 (.559)	.026 (.660)	.030 (.762)	.036 (.914)	.040 (1.016)	.044 (1.118)	.048 (1.219)	.052 (1.321)	.061 (1.549)
Coupling Speed Range — rpm	Falk LTG & NLGI #1 Grease	Min ‡	1030	700	550	460	380	330	290	250	230	210	190	160
		Allow	5300	4300	3700	3300	2900	2600	2400	2100	1900	1800	1600	1400
Grease – Pounds (kg)			.05 (.027)	.08 (.0363)	.14 (.0635)	.25 (.113)	.40 (.181)	.60 (.272)	1.00 (.453)	1.12 (.508)	2.00 (.907)	2.50 (1.13)	3.50 (1.59)	4.80 (2.18)
Flange Bolt Wrench Size (Inch Only)			.250	.375	.500	.625	.625	.750	.750	.750	.875	.875	.875	1.000
Flange Bolt Torque – lb-in (Nm)			108 (12.2)	372 (42.0)	900 (102)	1800 (203)	1800 (203)	3000 (339)	3000 (339)	3000 (339)	3000 (339)	3000 (339)	3000 (339)	3000 (339)

★ Refer to selection guide for maximum bores and Engineering 427-108 for reboring instructions.

† Flexible couplings are designed to accommodate changes in operating conditions. Coupling life expectancy between initial alignment and maximum operating limits is a function of load, speed and lubrication. Application requirements in excess of 1/4" misalignment per flex half coupling should be referred to the Factory for review.

‡ NLGI #0 grease must be used when speeds are below minimum shown.

Parts Identification

Coupling parts have identifying size and part numbers as illustrated below. When ordering parts, always specify SIZE and TYPE, hub bore & keyway and part number found on each item.

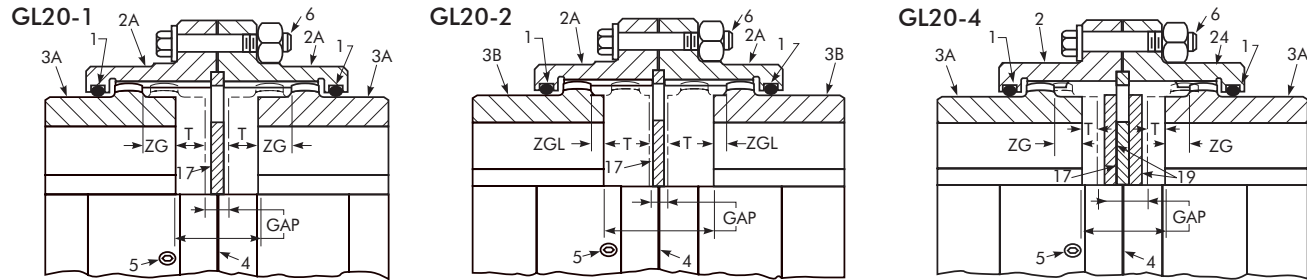

- | | | | |
|------------------------------------|---------------------|--------------|-----------------------|
| 1. Seal Ring | 3A. GL Flex Hub - 1 | 4. Gasket | 17. Center Plate |
| 2. G Flanged Sleeve (Short Tooth) | 3B. GL Flex Hub - 2 | 5. Lube Plug | 19. GL20-4 Gap Disc ★ |
| 2A. GL Flanged Sleeve (Long Tooth) | | 6. Fasteners | |
- ★ Not required for Sizes 1010 and 1020GL.

Part Number Location

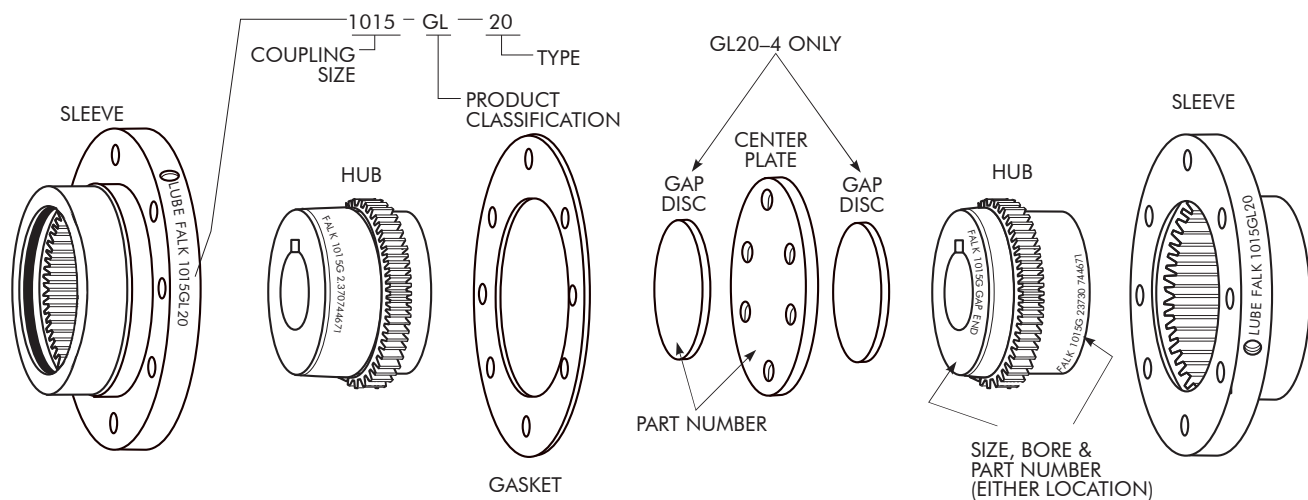

Order Information

- Identify part(s) required by name from Parts Identification above.
- Furnish the following information;

EXAMPLE:

Complete 1050GL20-1 Gear Coupling

Consisting of :

- 2 – 1050GL20 Sleeves
(Includes: Gasket & Seal)
- 2 – 1050GL-1 Flex Hubs
Bore: 6.750 Keyway: 1.750 x .750
Bore: 7.375 Keyway: 1.750 x .750
- 1 – Fastener Set
- 1 – Center Plate

Contact your Rexnord Distributor or the Factory for price and availability.